

Job Name:

Customer:

Representative:

Approved By:  Date:



P.O. Box 55  
Cheswick, Pennsylvania 15024

724-274-5430  
Fax: 724-274-5448

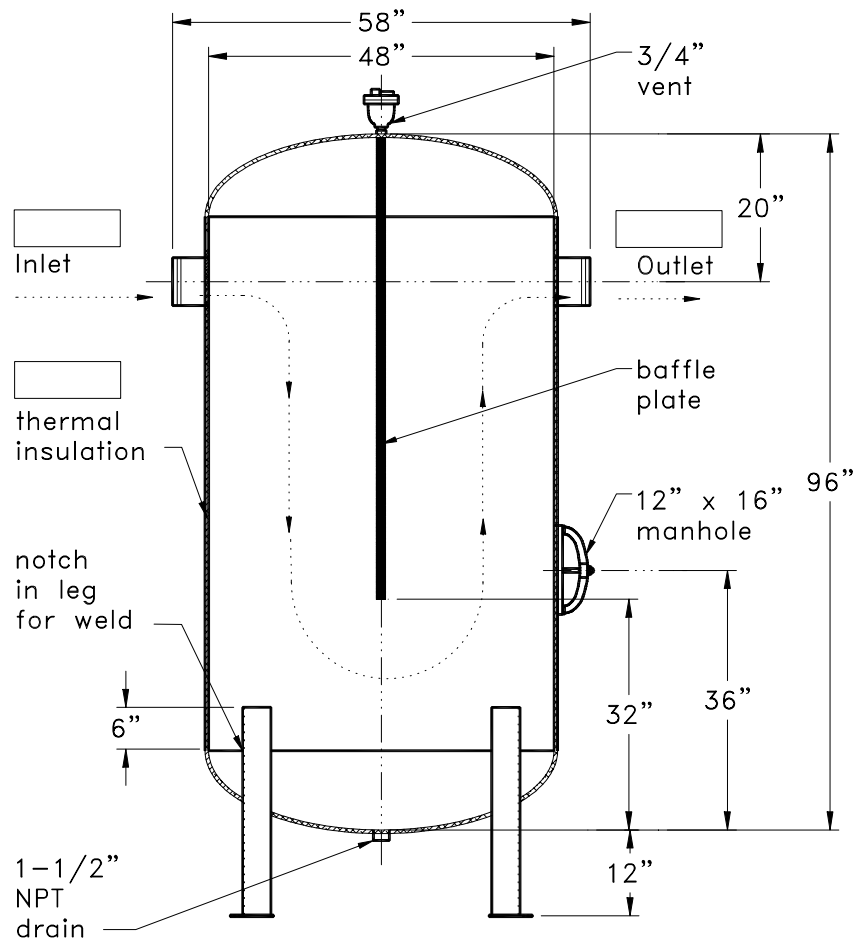
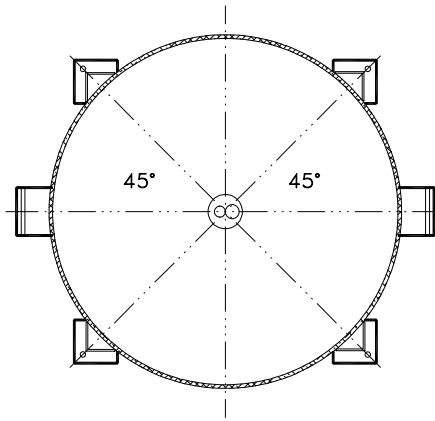

(4) 4"x4"x1/2"  
steel angle legs  
and 6"x6"x1/4"  
baseplates w/  
3/4"Ø hole in  
each plate on  
56" boltcircle

V680CWB-G-SL