

Job Name:

Customer:

Representative:

Approved By:  Date:



P.O. Box 55  
Cheswick, Pennsylvania 15024

724-274-5430  
Fax: 724-274-5448

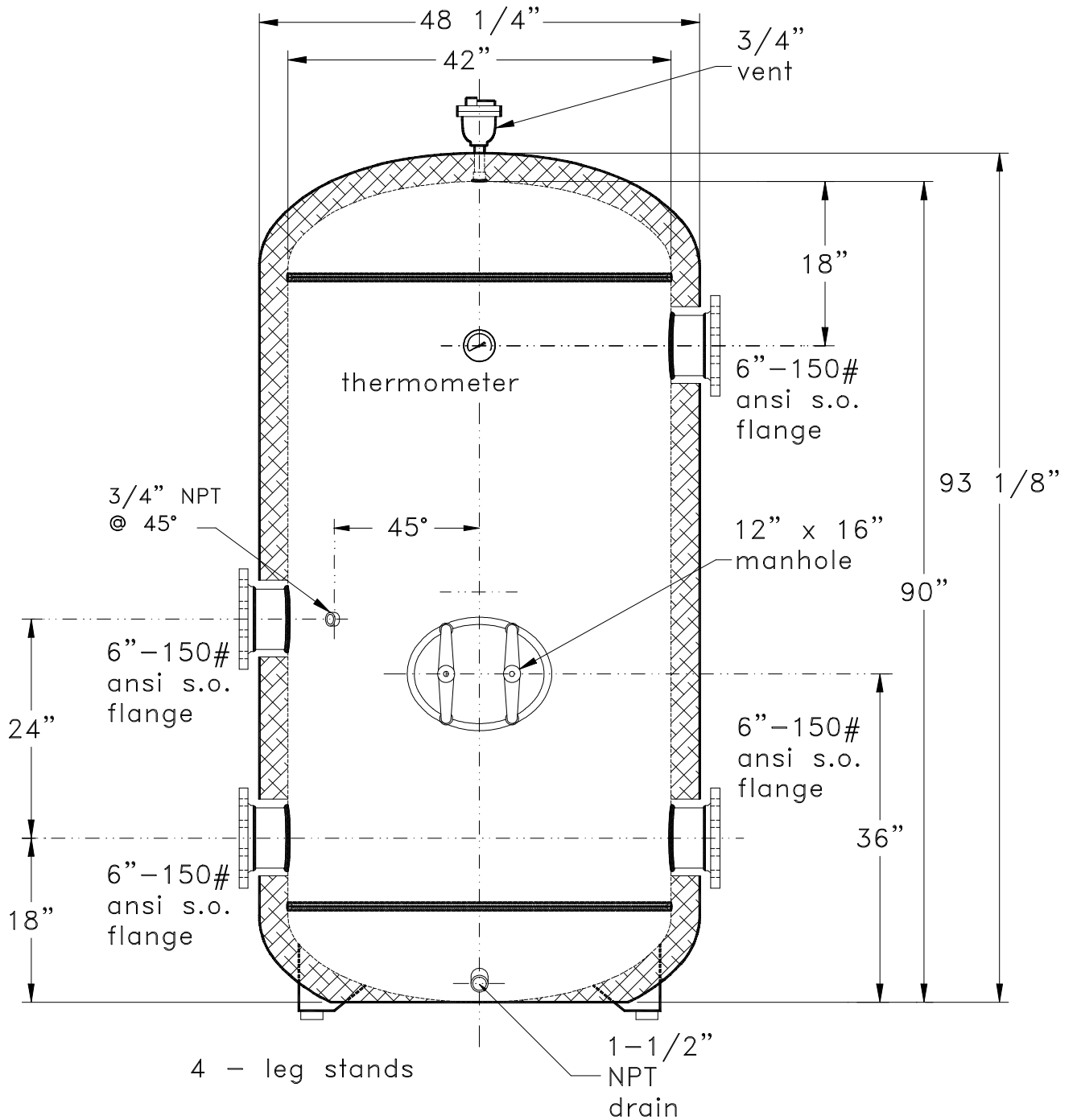

V500SEB