

Job Name:

Customer:

Representative:

Approved By: Date:



P.O. Box 55
Cheswick, Pennsylvania 15024

724-274-5430
Fax: 724-274-5448

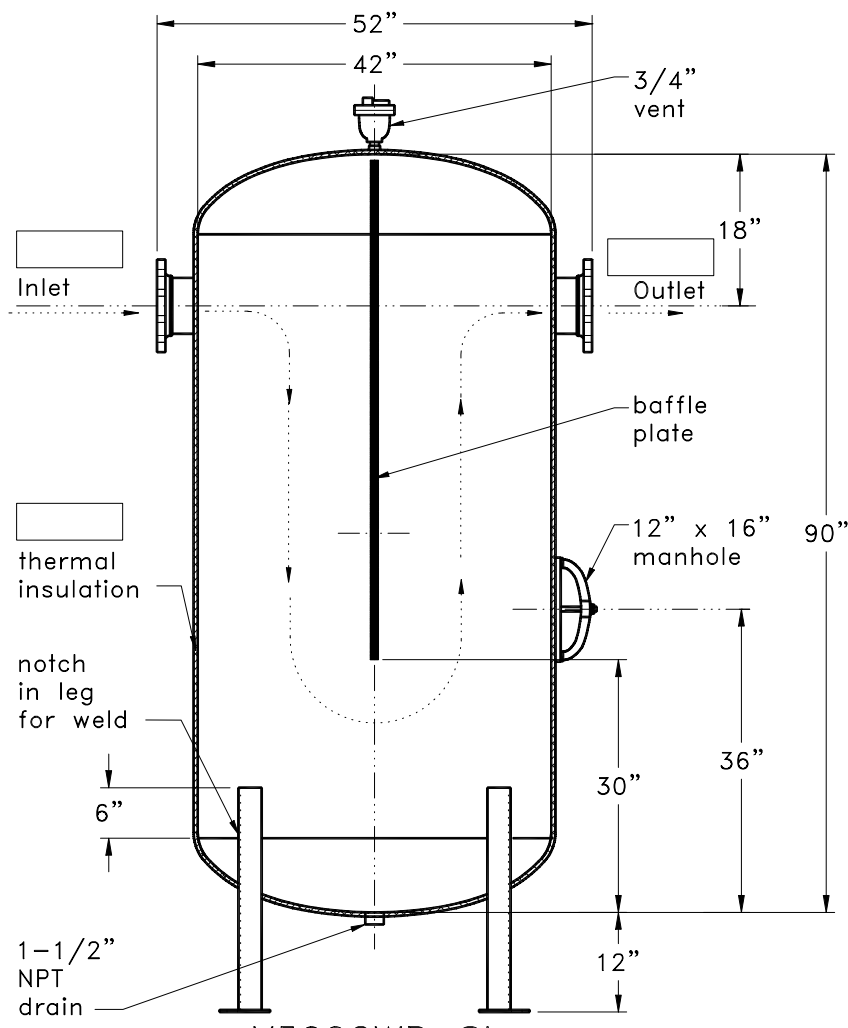
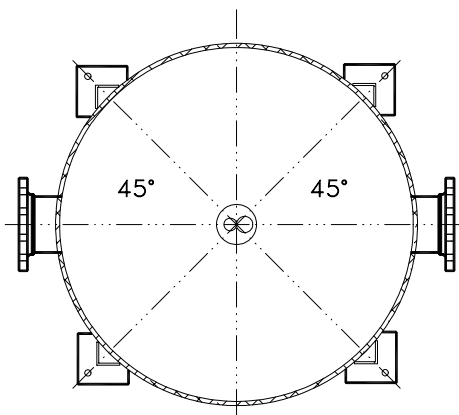

(4) 3"x3"x1/4"
steel angle legs
and 6"x6"x1/4"
baseplates w/
3/4"Ø hole in
each plate on
49" boltcircle

V500CWB-SL