

TOP

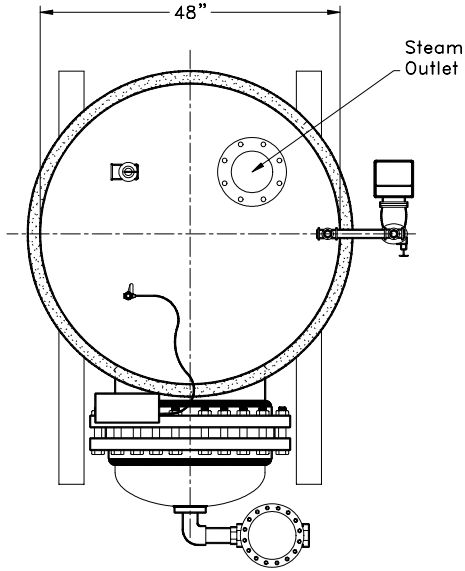

FRONT

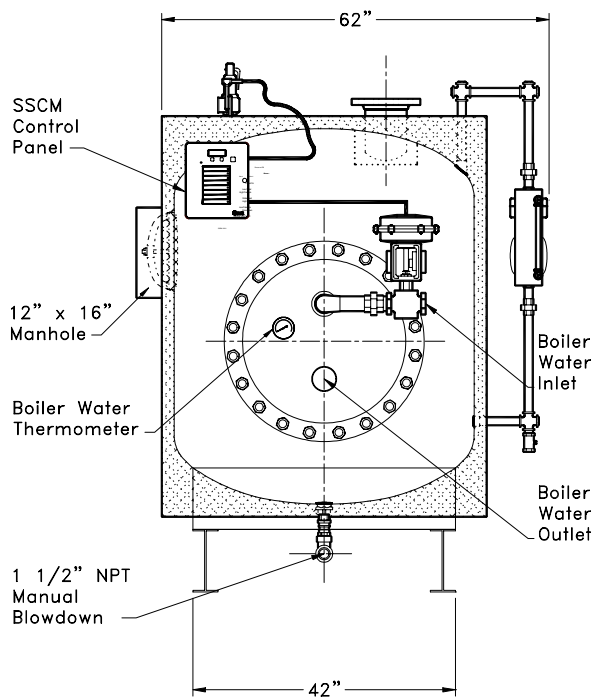

SIDE

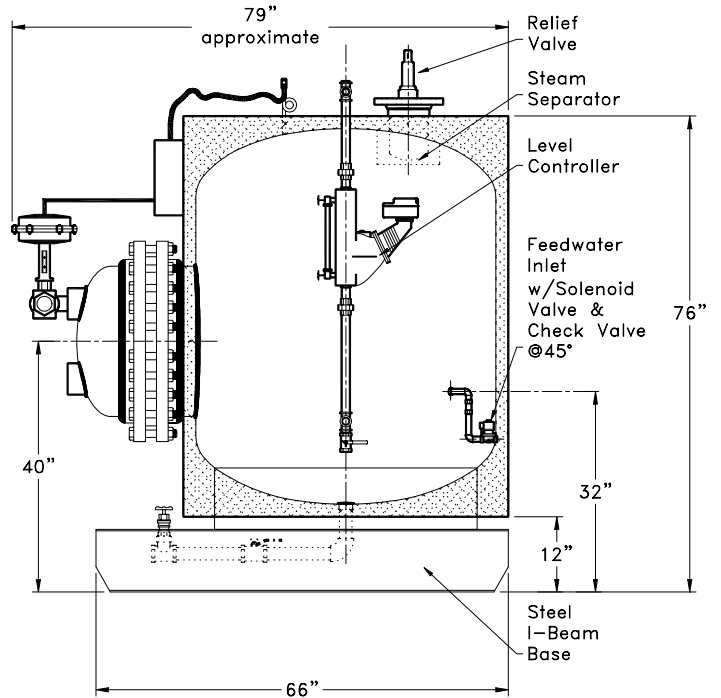

V410USG-W
Energy Source-Boiler Water