

Job Name:

Customer:

Representative:

Approved By: Date:



P.O. Box 55
Cheswick, Pennsylvania 15024

724-274-5430
Fax: 724-274-5448

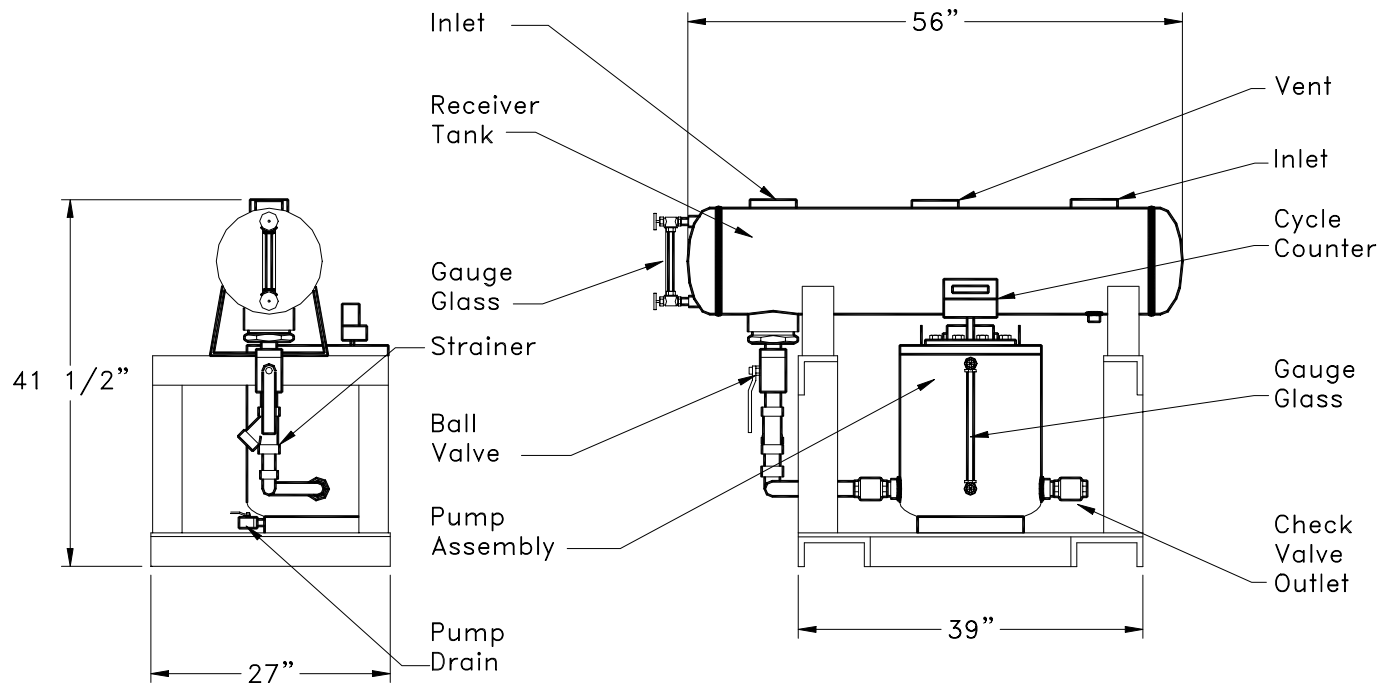

V18CCP-1X1-S-25