

Job Name:

Customer:

Representative:

Approved By: Date:



P.O. Box 55
Cheswick, Pennsylvania 15024

724-274-5430
Fax: 724-274-5448

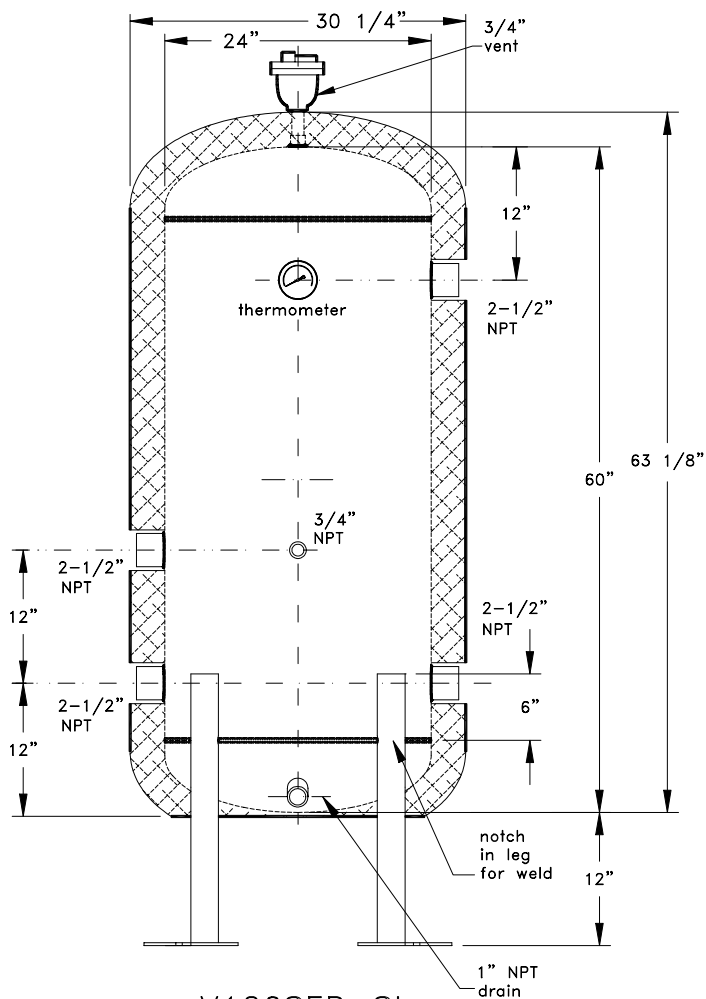
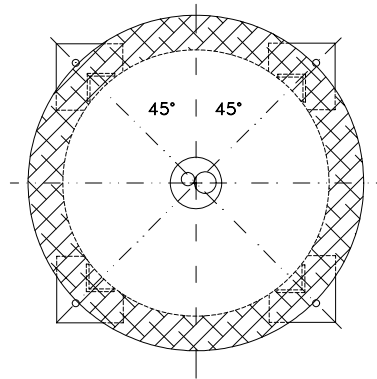

(4)
2-1/2"x2-1/2"x1/4"
steel angle legs and
6"x6"x1/4" baseplates
w/ 3/4"Ø hole in each
plate on 30-5/8"
boltcircle

V120SEB-SL