

Job Name:
Customer:
Representative:
Approved By: Date:

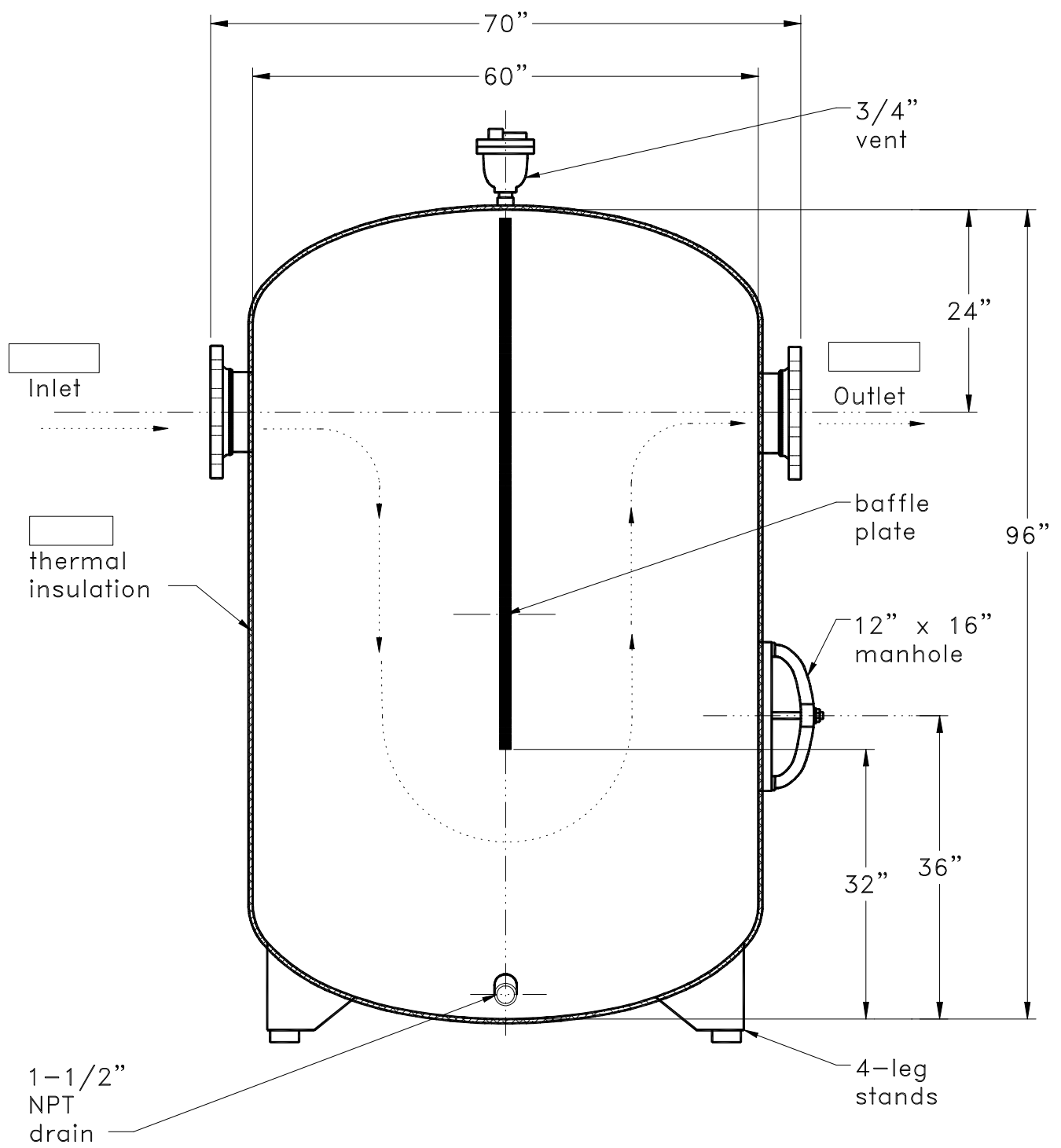

P.O. Box 55
Cheswick, Pennsylvania 15024
724-274-5430
Fax: 724-274-5448



V1040CWB