

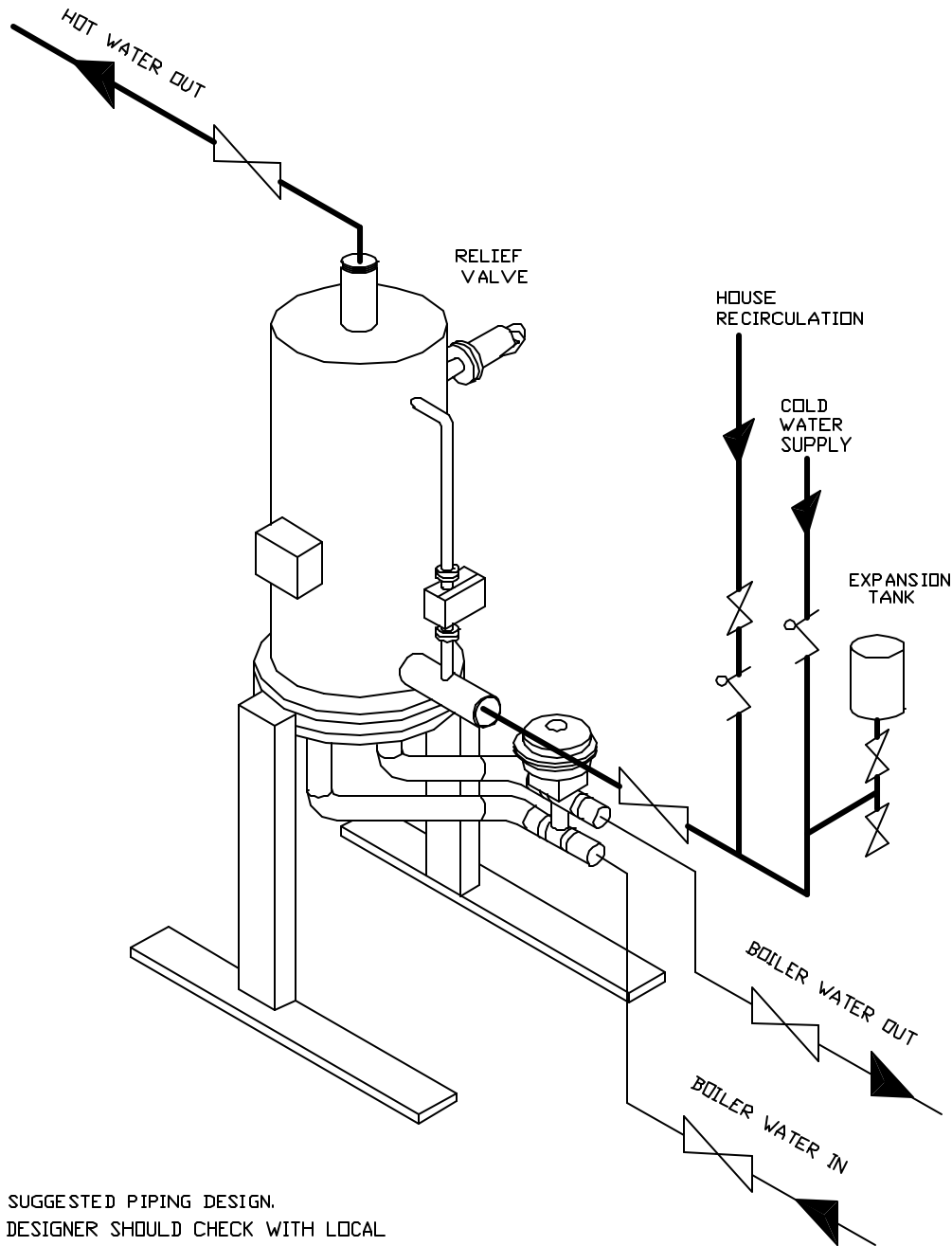
	STOP VALVE
	CHECK VALVE
	CIRCULATOR

SEH SERIES
BOILER FIRED WATER HEATER
3-WAY CONTROL VALVE



NOTES: SUGGESTED PIPING DESIGN.
DESIGNER SHOULD CHECK WITH LOCAL
CODES TO VERIFY COMPLIANCE.

PIPE ALL RELIEF VALVES TO DRAIN.